



2014 Field Operations in Review

Liquid Assets Review:
from Source to Course

Source

Granlees Pumping & Diversion Station

- 2012-2013 Pumping Season: 2,208.2 Ac. ft. (719.5 MG) pumped
Started filling on December 8, 2013.
- 2013-2014 Pumping Season: 2,322 Ac. ft. (756.5 MG) pumped
Started filling on February 9, 2014.
- **2014-2015 Pumping Season:** 641 Ac. ft. (209 MG) pumped *so far*
this season (as of 2/16/15)
Started filling on December 6, 2014.

The District may pump water from the Cosumnes River from November 1 thru May 31 of each year for raw water storage. Amounts and times vary depending on river flow. River diversion through the Cosumnes Irrigation Association (CIA) ditch is utilized to convey water for downstream uses.

Annual Amounts Pumped from River to Storage

TOTAL WATER PUMPED FROM GRANLEES DAM TO STORAGE

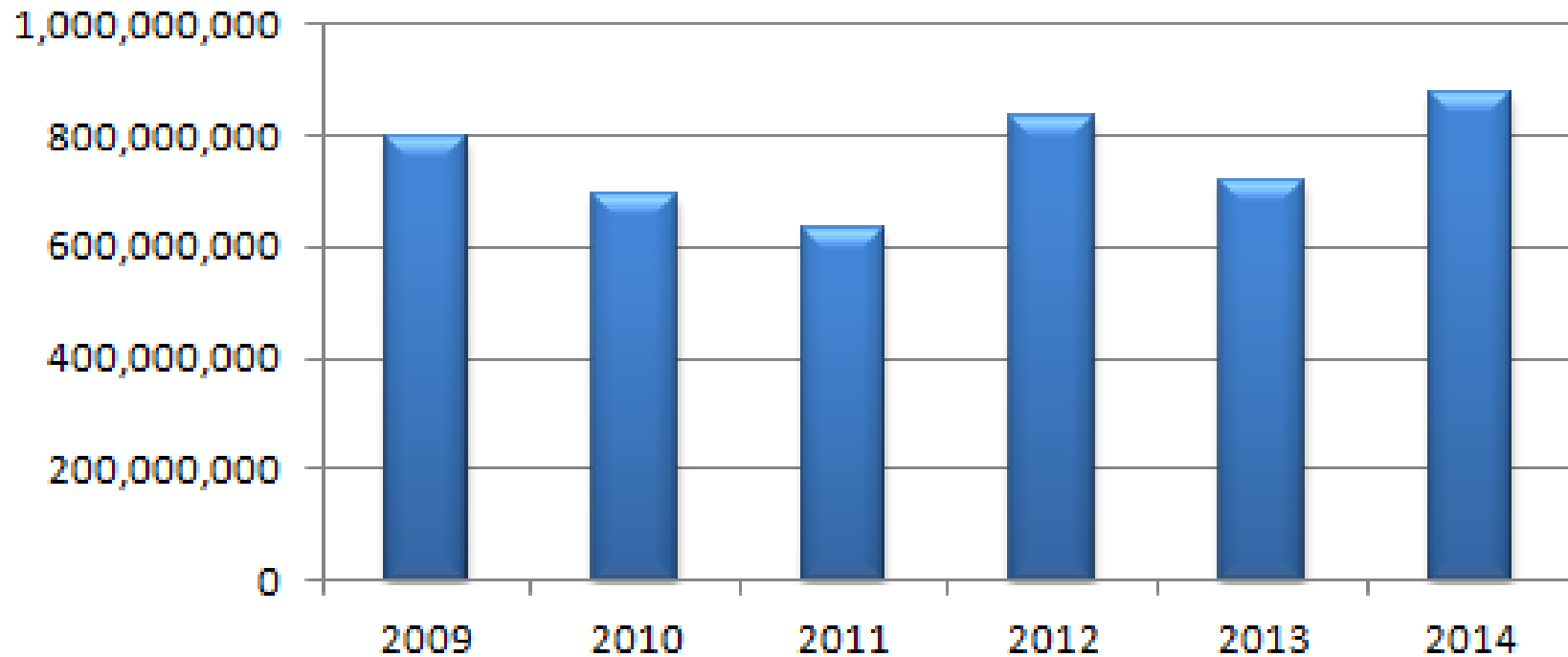

Water Production

474.8 MG (1,457.2 Ac. ft.) of potable water was produced in 2014

Yearly Totals in Millions of Gallons

Year	Jan.	Feb.	March	April	May	June	July	August	Sept.	Oct.	Nov.	Dec.	Total MG	Ac.ft.
2010	29.577	21.172	24.259	30.448	41.214	63.425	78.839	88.032	80.959	57.975	29.389	19.197	564.486	1732.5
2011	13.747	12.940	16.614	31.897	50.879	54.096	73.512	76.750	71.188	50.277	31.516	29.642	513.058	1575
2012	27.105	23.894	24.565	28.111	55.631	69.697	78.050	80.757	68.669	51.197	24.799	18.705	555.135	1691.5
2013	19.17	19.73	32.74	41.27	61.93	68.63	80.71	76.74	63.82	55.10	38.54	28.81	587.21	1802.2
2014	28.63	18.44	21.93	27.21	47.58	60.84	66.75	61.83	49.48	42.54	29.01	20.55	474.78	1457.2

Water Usage

Annual Rainfall vs. WTP Production

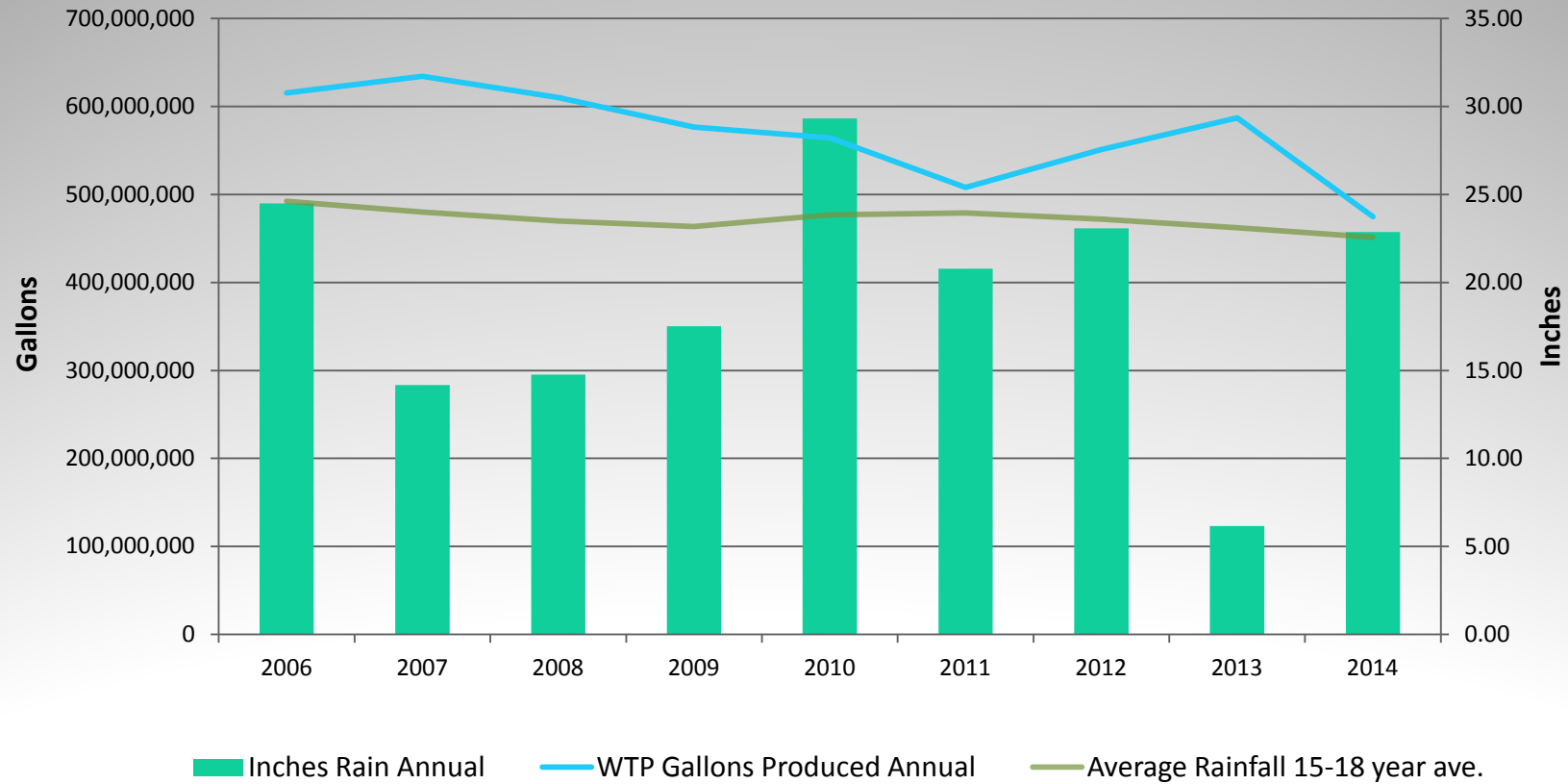



WATER CONSERVATION

WTP Production & Consumer Consumption

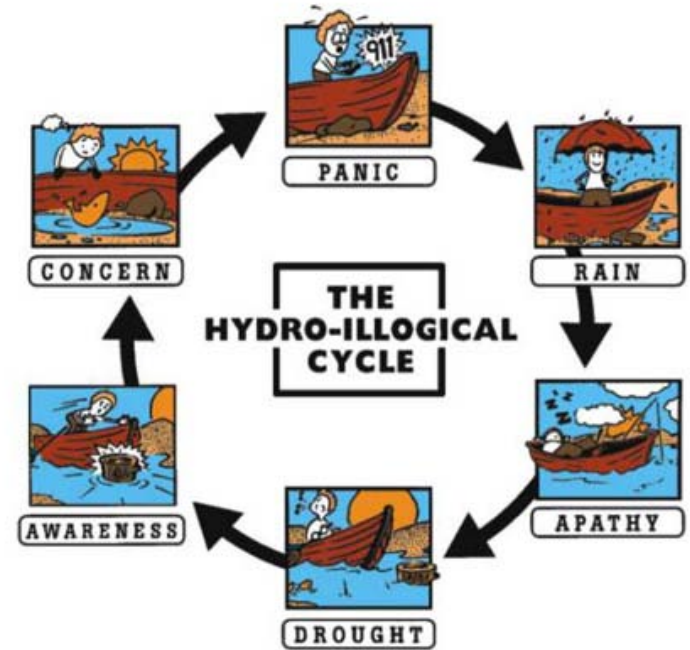
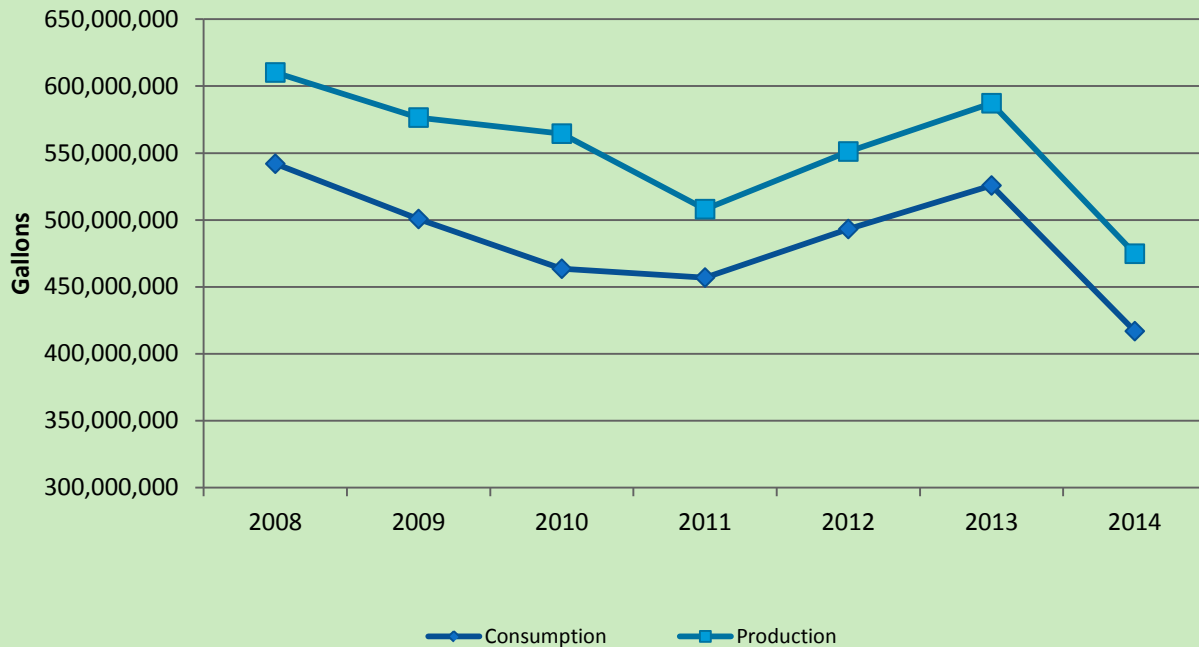

Production down **19%** vs. 2013
thanks to conservation efforts

Water Distribution Maintenance

- Conducted a leak audit in spring of 2014
- 62 Water Leak Repairs in 2014

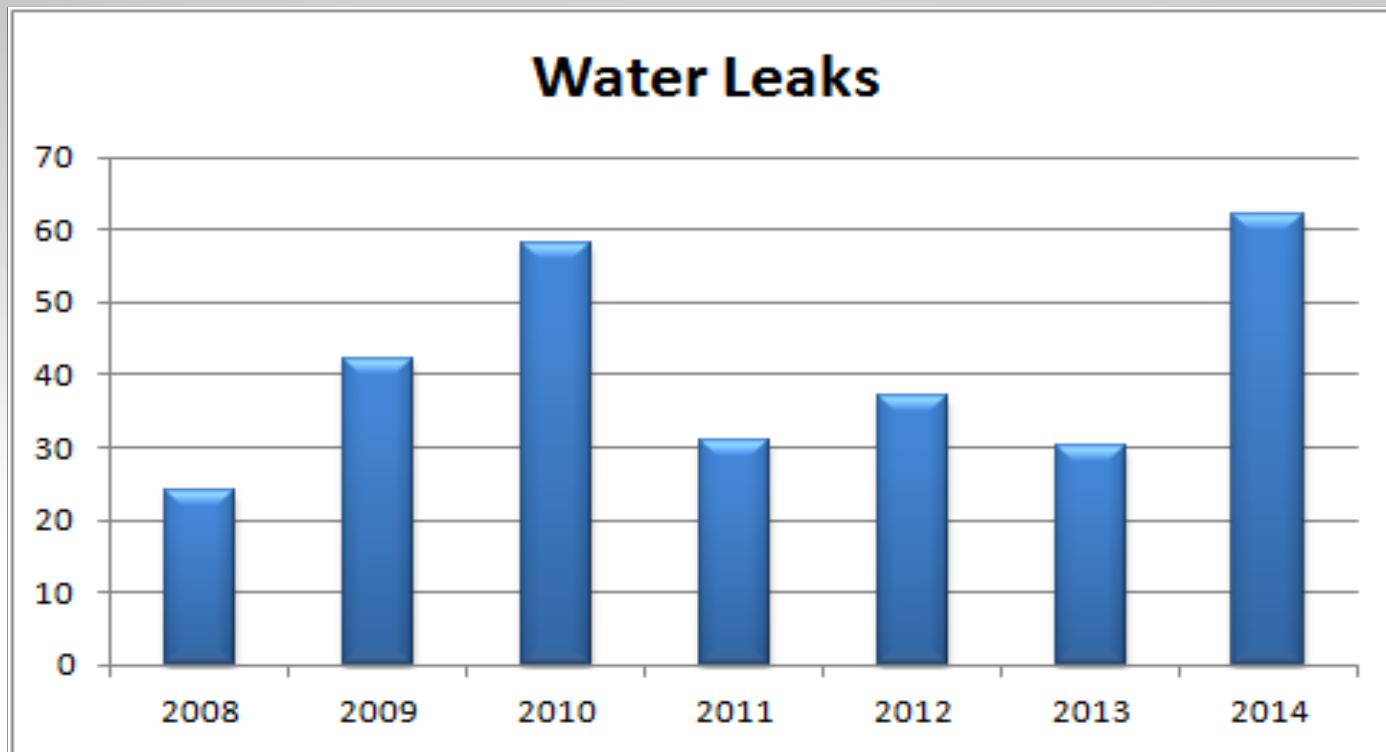



General Mineral Analysis 2014

ND = None Detected mg/L = Milligrams per liter MCL = Maximum Contaminant Level

MCL	REPORTING UNITS	CHEMICAL	ANALYSES RESULTS
-	mg/L = ppm	Hardness, (Total) as CaCO ₃	44
-	mg/L	Calcium (Ca)	9.5
-	mg/L	Magnesium (Mg)	4.9
-	mg/L	Sodium (Na)	5.2
-	mg/L	Potassium (K)	1.1
-	mg/L	Alkalinity, (Total) (as CaCO ₃ equivalents)	40
-	mg/L	Hydroxide (as OH)	ND
-	mg/L	Carbonate (as CO ₃)	ND
-	mg/L	Bicarbonate (as CaCO ₃)	45
*	mg/L +	Sulfate (SO ₄)	4.0
*	mg/L +	Chloride	3.1
45	mg/L	Nitrate (NO ₃)	ND
2.0	mg/L	Fluoride (F) (Natural-Source)	ND
	Std Units +	pH, Laboratory	7.78
**	umhos +	Specific Conductance (E. C.)	120
***	mg/L +	Total Filterable Dissolved Residue @ 180 C (TDS)	72
15	UNITS	Color, Apparent (Unfiltered)	ND
3	TON	Odor Threshold @ 60 C	ND
0.5	mg/L +	MBAS	ND
1000	ug/L = ppb	Aluminum (Al)	ND
6	ug/L	Antimony	ND
10	ug/L	Arsenic (As)	ND
1000	ug/L	Barium (Ba)	ND
4	ug/L	Beryllium	ND
5	ug/L	Cadmium (Cd)	ND
50	ug/L	Chromium (Total Cr)	ND
1000	ug/L +	Copper (Cu)	ND
300	ug/L +	Iron (Fe)	ND
	ug/L	Lead (Pb)	ND
50	ug/L +	Manganese (Mn)	ND
2	ug/L	Mercury (Hg)	ND
100	ug/L	Nickel	ND
50	ug/L	Selenium (Se)	ND
100	ug/L +	Silver (Ag)	ND
2	ug/L	Thallium	ND
5000	ug/L	Zinc (Zn)	ND
6	ug/L	Perchlorate	ND

2014 Distribution System Meter Repairs

- Total MXU's Replaced- 54
- Total Meters Replaced- 89

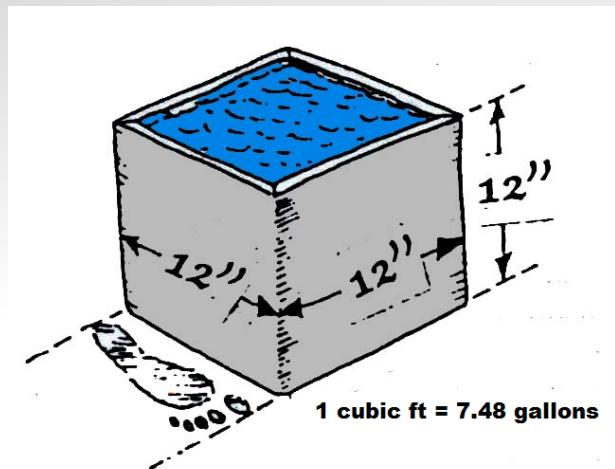

Meters are used to bill customers based on their water use at \$0.0153 per cubic foot, helping to encourage water conservation.

Wastewater Treatment System Overview

- 2014 influent flow received was **139.4 MG** (427.8 acre-feet)
- Treated wastewater is stored in two reservoirs until needed for reclamation use by RMCC during summer months.

• Stored secondary treated wastewater is pumped through a DAF system and then filtered, disinfected with chlorine, becoming tertiary treated water, and supplied to the golf courses for irrigation.

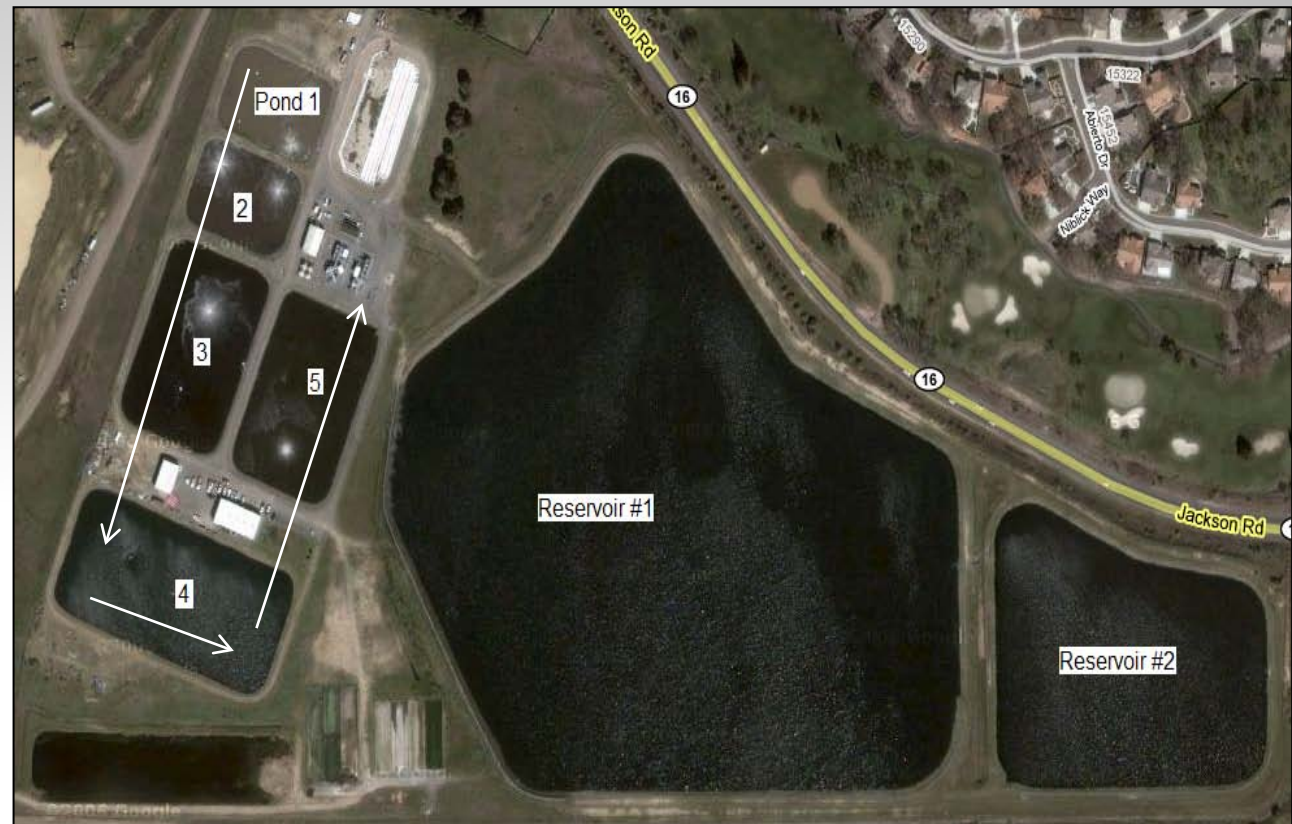

To Course

132.3 MG
(405.9 Acre-feet)
of tertiary water
was produced in
2014 for RMCC
irrigation use.



Sewer Metrics

Sewer Line Cleaned - Feet

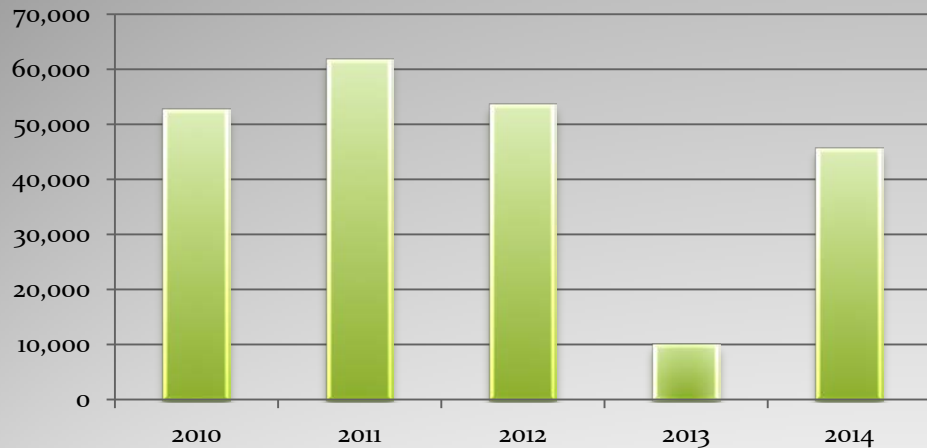

Total Wastewater Returned to Plant From Customers

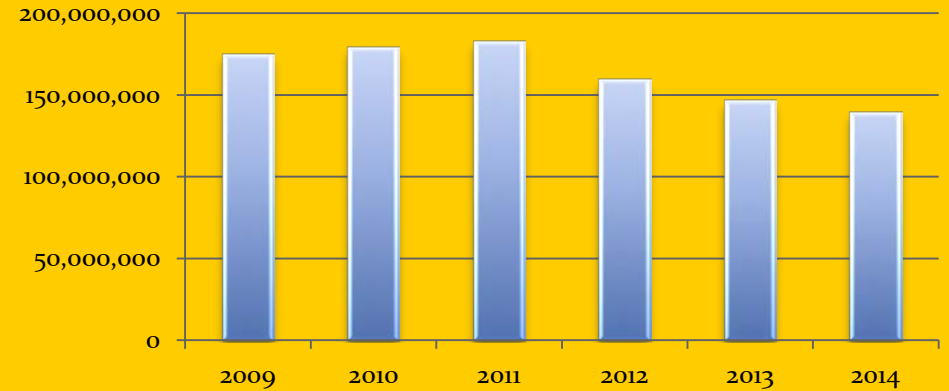

Sewer Blockages



TREATED RECLAIMED WASTEWATER DELIVERED FOR GOLF COURSE IRRIGATION

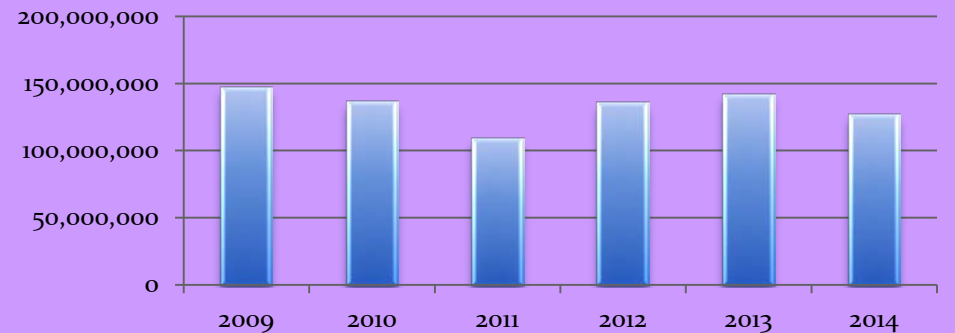

We effectively lowered secondary wastewater storage to 28 acre-feet. The highest storage volume for the year was 331 acre-feet.

Volume of Secondary Wastewater in Reservoirs 2011-2014

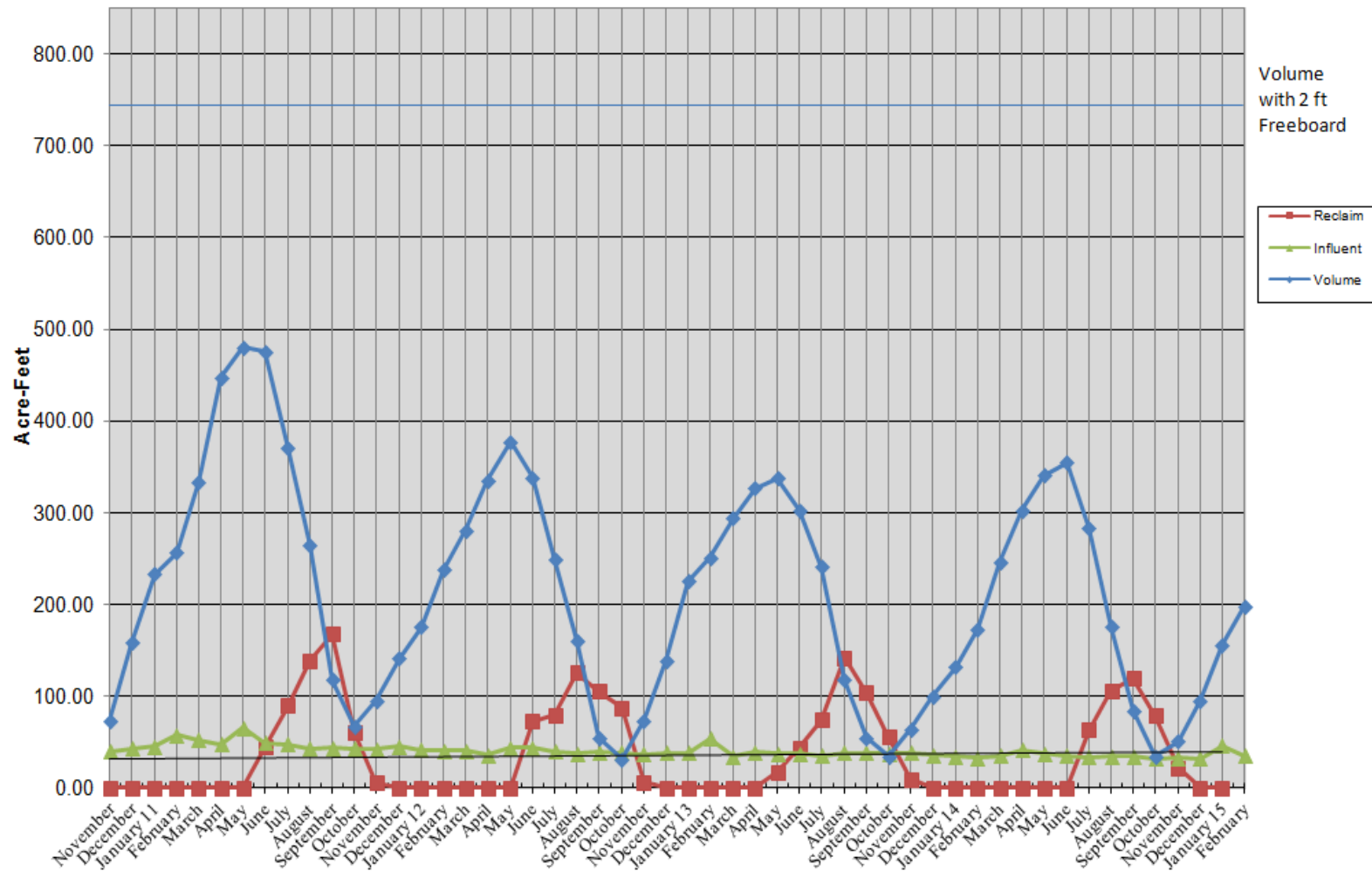

SMUD Power Costs

Primary Electrical Accounts - Annual Costs

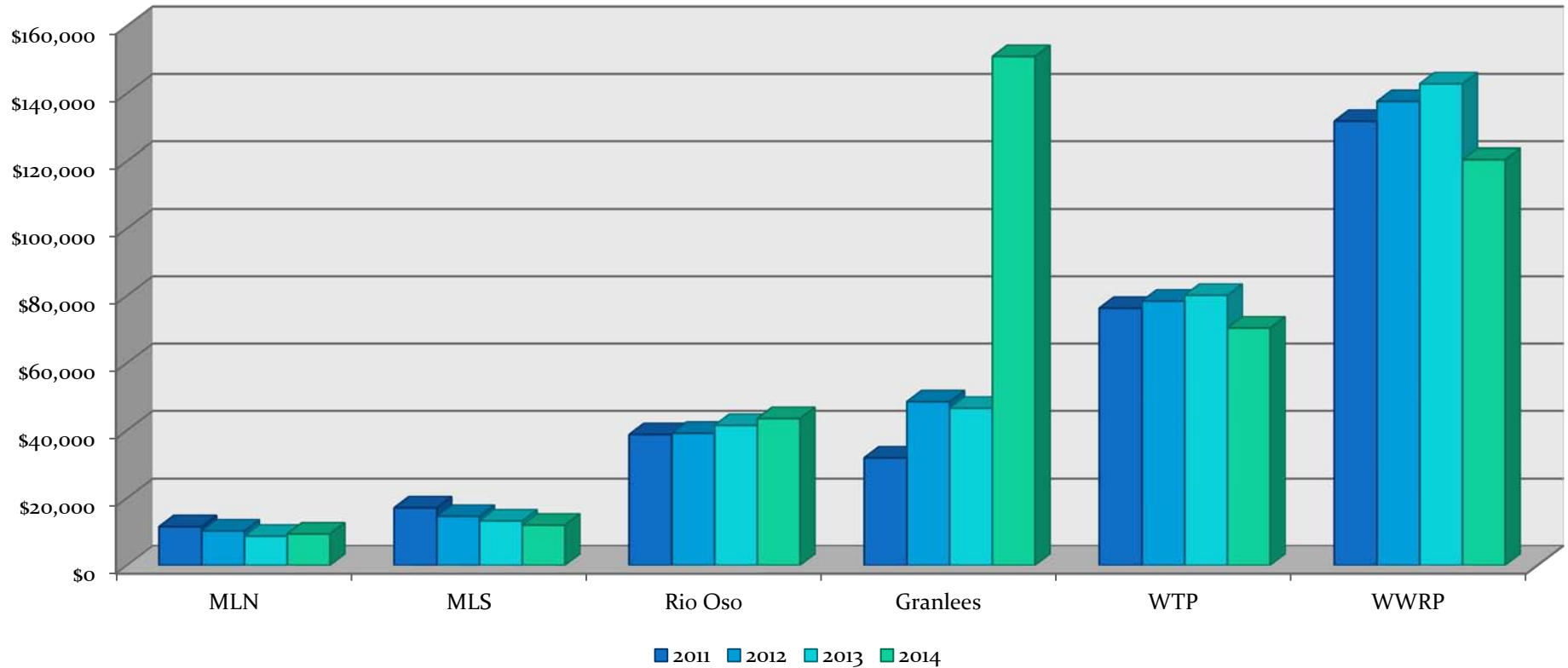

Projects Completed

● Sewer

- Received Master Reclamation Permit & Waste Discharge Requirements for recycled water
- Hauled away 239 tons of dried biosolids from facility
- Removed 112,600 gallons of settled sludge from process Ponds
- Finished rehabilitation of Main Lift North sewer pumping station wet wells and two manholes leading up to station
- Repaired two sewer mains on Lago Drive

● Water

- Bid, awarded, and began construction on Water Treatment Plant Expansion project
- Replaced 36" valve on raw water line below Chesbro Reservoir
- Made repairs to Granlees diversion structure
- Cleaned out Water Plant #1 & #2 sedimentation basins
- Replaced sand and valve in solids drying beds

● Drainage

- Completed replacement of drainage culvert across hole #13, below green, on the north course in summer of 2014

2015 Goals

Water

- Ensure water supply is available to meet community needs
- Complete WTP#1 expansion – on time and within budget
- Ensure alternative supply and/or treatment is available if WTP#1 schedule is delayed
- Complete the Augmentation Well project
- Evaluate increasing storage capacity of reservoirs
- Closely monitor number of connections as we near qualifying as an Urban Water Supplier (3,000 connections) in the next few years
- Participate in/with regional agencies, associations, etc. to stay informed at the regional and state level of water issues
- Update long term maintenance plan and identify estimated cost of future repairs/replacements - Reserve Study
- Evaluate ways to increase efficiency, reduce costs, and find alternative funding for specific projects - Grants

Wastewater

- Ensure wastewater treatment and disposal facilities are adequate to meet future needs
- Continue coordinating with developers on development schedule and impact to amount of wastewater produced – develop facility update/expansion schedule and plan accordingly; leveraging existing recycled water system
- Conduct rate study for development of recycled water rates
- Develop process/procedure for recycled water permit issuance
- Evaluate alternative methods of using reclaimed water, such as Indirect Potable Reuse
- Coordinate with current users (VVR and RMCC) on use of reclaimed water and what the new WDR means
- Participate in/with regional agencies, associations, etc. to stay informed at the regional and state level of wastewater issues
- Update long term maintenance plan and identify estimated cost of future repairs/replacements - Reserve Study
- Evaluate ways to increase efficiency, reduce costs, and find alternative funding for specific projects
- Develop reclaimed water plan

Drainage

- Ensure drainage system is able to efficiently handle drainage water
- Evaluate drainage culverts and review/update maintenance schedule as needed
- Update long term maintenance plan and identify estimated cost of future repairs/replacements - Reserve Study
- Evaluate ways to increase efficiency, reduce costs, and find alternative funding for specific projects

Thank You

With the continued support of the Board and community, we will continue to make improvements and keep the District running with a high standard of service and operation.